

# Sin

Antoni Arola. 2013  
Table Lamps



## Metal structure:



White



Graphite

## Lampshades:



Methacrylate



White aluminium



Graphite aluminium

Sin S

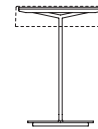

A

Sin L

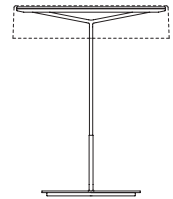

B

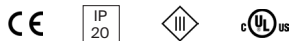

Free of adornments, the Sin lamp takes its name from the Spanish word 'without' as it can even be used sans shade. Antoni Arola combined a simple design with LED technology to create a lucent ring of light suspended in the air. The light can be dimmed with a switch housed in the base, while the larger Sin model on full power can broadly light up any work surface.

Both models are available in a matte white or graphite finish. A clear white shade or an opaque aluminium shade may be added. Or just leave them shade free.

## General description:

Metallic structure with two matte finish options:

White grey: optional white translucent methacrylate or white aluminium lampshade.

Graphite: optional graphite aluminium lampshade.

Dimmer and switch incorporated into the luminaire.

Electric cable length: 3 m / 118.11"

## Approximate weight (unpacked):

(A) Sin S: 2,5 Kg / 5.5 lb (structure). 0,4 Kg / 0.9 lb (lampshade)

(B) Sin L: 4,9 Kg / 10.8 lb (structure). 1 Kg / 2.2 lb (lampshade)

## Technical information:

Light source included (dimnable)

LED Module

(A) Sin S:

Rated input wattage: 12,5 W

Luminous flux:

Without lampshade: 680 lm

With methacrylate lampshade: 630 lm

With white aluminium lampshade: 494 lm

With graphite aluminium lampshade: 377 lm

Operating voltage: 24 VDC

CCT : 2.700 K

CRI: 90

Lifetime: 40.000 h

Built-in dimmable LED

Suitable only for indoor use.

(B) Sin L:

Rated input wattage: 25 W

Luminous flux:

Without lampshade: 1.360 lm

With methacrylate lampshade: 989 lm

With white aluminium lampshade: 1.261 lm

With graphite aluminium lampshade: 754 lm

Input voltage: 90 ~ 264 Vac.

(50 Hz / 60 Hz). According to destination.

# Sin

Antoni Arola. 2013  
Table Lamps

## Without lampshade

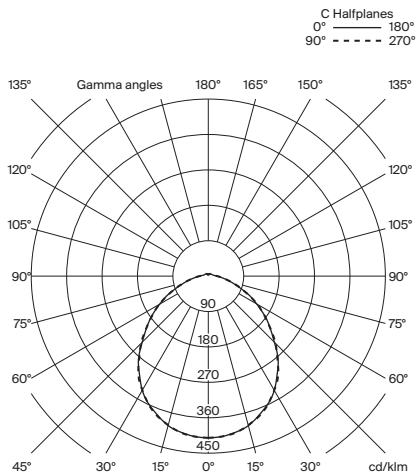

## With methacrylate lampshade

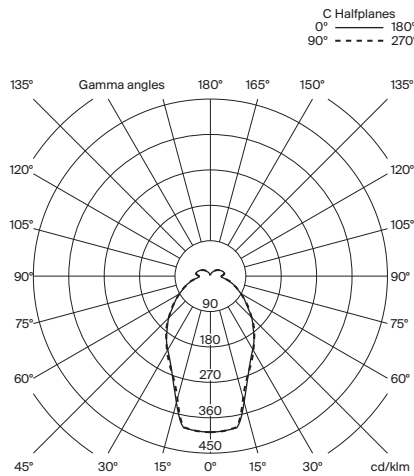

## With aluminium lampshade

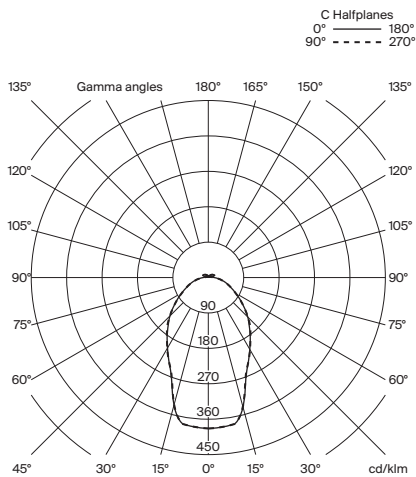

### Regulations:

European version  
UNE-EN 60598  
UNE-EN 55015  
UNE-EN 62031  
UNE-EN 61000-3-2  
UNE-EN 60529  
UNE-EN 61347-2-13

American version  
Dry location only  
UL-1598  
UL-8750  
UL-336377

### Maintenance:

Clean with a smooth cloth. Do not use ammonia, solvents or abrasive cleaning products.

### Others:

Without lampshade: the lamp is delivered in one package.  
With lampshade: the lamp is delivered in different packages.  
The assembly instructions are delivered with the product.

**Model A: Sin S**

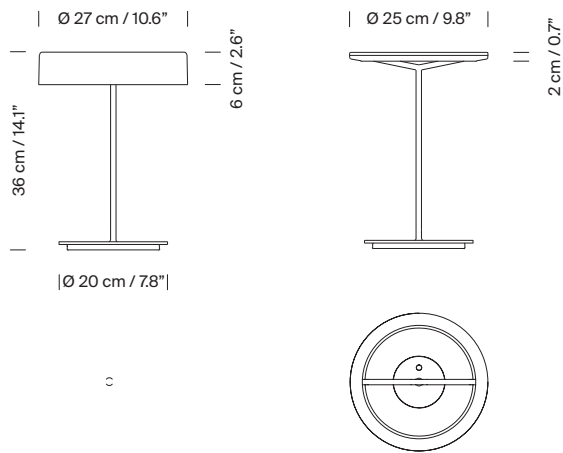

**Model B: Sin L**

