

Moragas

Antoni de Moragas Gallissà. 1957
Table Lamps



At the age of forty-four, Antoni de Moragas Gallissà designed the Moragas lamp for his own office. Rationalist architect and first president of the Association of Industrial Design FAD, he was an instigator of the architectural renewal in post-war Spain. Moragas had this lamp on his desk and would often use it to place notes and business cards he'd receive, inserting them between the ribbon folds.

A sturdy wood cylinder supports a head with three bulbs arranged radially and outwards, surrounded by a generous circular shade. The shade is made from cotton ribbon (typically used for bookbinding) and has a thread running along the edge, forming an asymmetry that creates a splendid contrast of light and shadow.

General description:

Sapele wood or natural oak wood leg.
Natural cotton ribbon lampshade with border.
Electric cable length: 2,25 m / 88.6"

Approximate weight (unpacked):

4,4 Kg / 9.7 lb

Technical information:

European version: Light source included (dimmable)
American version: Recommended dimmable light source (not included)
3 x LED bulb: 7,8 W / 1.521 lm / 2700K
E27 - E26 / Max. hgt. 115 mm / 4.5"

Includes dimmer (dimmable light source required).
Suitable only for indoor use.
Always use the light source recommended or equivalent.

Input voltage: 100, 120, 230 Vac.
(50 Hz / 60 Hz). According to destination

Regulations:

European version
UNE-EN 60598
UNE-EN 55015
UNE-EN 60529

American version
Dry location only
UL-153
E-352592

Moragas

Antoni de Moragas Gallissà. 1957
Table Lamps

Maintenance:

Clean with a smooth cloth. Do not use ammonia, solvents or abrasive cleaning products.

Others:

The lamp is delivered in different packages.
The assembly instructions are delivered with the product.

Model:

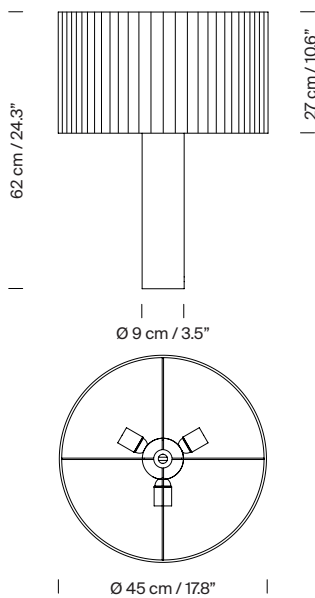

Collection:

Table lamps

Furniture



Moragas



Moragas