

Cirio Múltiple

Antoni Arola. 2010

Pendant lamps



Lampshades



Canopies



The composition of multiple focal points: Cirio Múltiple allows you to distribute between 6 and 12 points of light from a single canopy. This freedom makes it easy and clean to direct accent lighting toward different settings within the same space.

The Cirio family has four shade options. The handcrafted Sargadelos porcelain, whose translucence bathes the white shade in amber, provides a diffuse and very warm light. In its striped version, it also gains texture and three-dimensionality. For greater luminous efficiency, opal glass offers a more intense and economical alternative. Finally, the opacity of brass allows for focused, directional lighting.

General description:

Capsule with LED module, translucent white diffuser and heat sink with black matte finish.

4 lampshade options: white porcelain, white Pana porcelain, white opal glass and polished brass.

3 metal circular ceiling plate options with power supply incorporated for a minimum of 6 and a maximum of 12 light sources:

Surface-mounted: white or black with matte finish.

Recessed (European version): white.

S&C LED capsule suitable with HeadLed System lampshades.

Suitable for Junction Box (American version).

Electric cable length: 3 m / 118.1" - 8 m / 315"

Approximate weight (unpacked):

8 Kg / 17.5 lb*

Lampshades:

Porcelain: 0,5 kg / 1.1 lb

Pana porcelain: 0,4 kg / 0.8 lb

Glass: 0,6 kg / 1.3 lb

Brass: 0,3 Kg / 0.7 lb

*Weight with porcelain lampshade

Cirio Múltiple

Antoni Arola. 2010
Pendant lamps

Technical information:

Dimmable light source included
Capsule with LED module

Rated input wattage: 6/12 x 11 W
Operating current: 700 mA
CCT: 2.700 K
CRI: 90
Lifetime: 40.000 h
Luminous flux:
Porcelain: 6/12 x 222 lm
Pana porcelain: 6/12 x 307 lm
Glass: 6/12 x 656 lm
Brass: 6/12 x 237 lm

European version: suitable for dimming 1-10V / DALI. Not included external dimmer switch 1-10V / DALI.
American version: suitable for dimming 1-10V. Not included external dimmer switch 1-10V.

Suitable for indoor use.
Always use this light source.

Input voltage: 120 ~ 277 Vac.
(50 Hz / 60 Hz). According to destination.

White porcelain lampshade

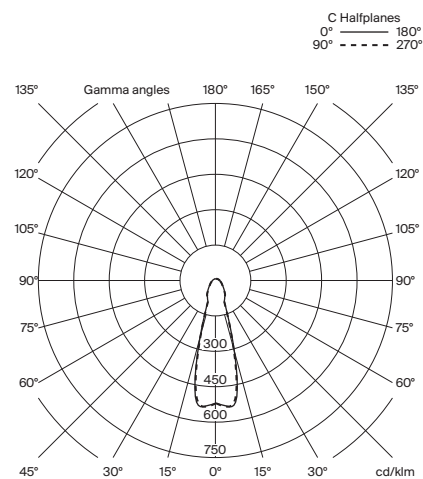

White Pana porcelain lampshade

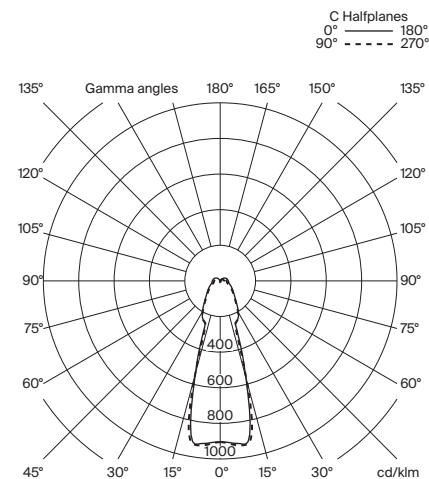

White opal glass lampshade

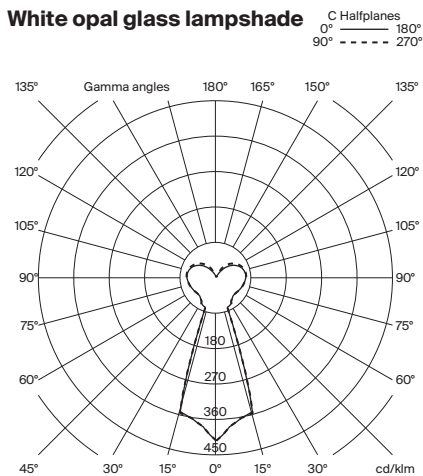

Brass lampshade

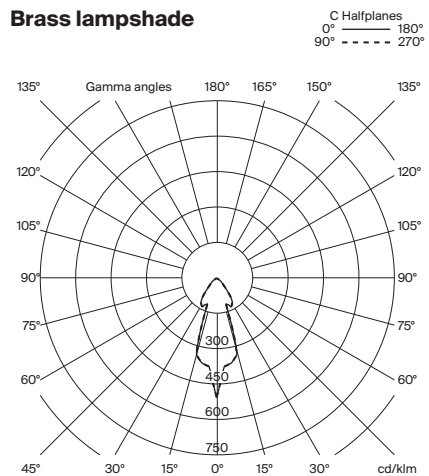

Cirio Múltiple

Antoni Arola. 2010
Pendant lamps

Regulations:

European version
UNE-EN 60598
UNE-EN 55015
UNE-EN 62031
UNE-EN 61000-3-2

American version
Dry and damp location
UL-1598
UL-8750
E-336377

Maintenance:

Clean with a smooth cloth. Do not use ammonia, solvents or abrasive cleaning products.

Others:

The lamp is delivered in different packages.
The assembly instructions are delivered with the product.

Models / Codes: European Version)



Canopies

Surface

Built-in

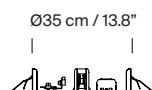
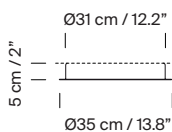

Multiple canopy	Dimming	Code
Black surface	1-10 V	CIF11
	DALI	CIF11-DALI
White surface	1-10 V	CIF12
	DALI	CIF12-DALI
White built-in	1-10 V	CIF22
	DALI	CIF22-DALI

Lampshades

White porcelain

White Pana porcelain

White opal glass

Brass

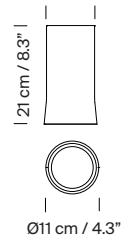
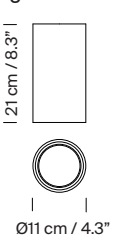
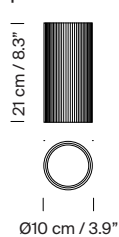
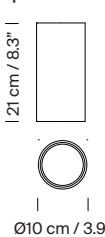

Lampshade	Code
White porcelain	CIP01
Pana white porcelain	CIP07
White opal glass	CIP05
Polished brass	CIP06

LED capsule with electric black cable	Code
3 m / 118.1"	8CAP03
8 m / 315"	8CAP08

Possible arrangements

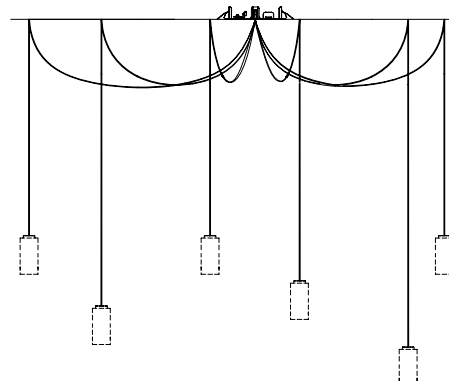
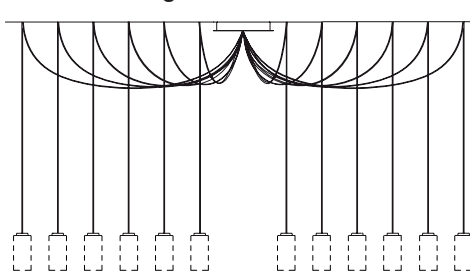

Cirio Múltiple

Antoni Arola. 2010
Pendant lamps



Models / Codes: American Version

Lampshades

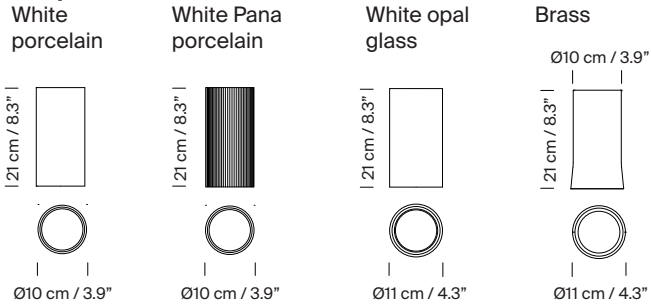

Lampshade	Code
White porcelain	CIP01
Pana white porcelain	CIP07
White opal glass	CIP05
Polished brass	CIP06

Multiple canopy	Code
Matte black surface	CIF11UL
White surface	CIF12UL

Possible arrangements

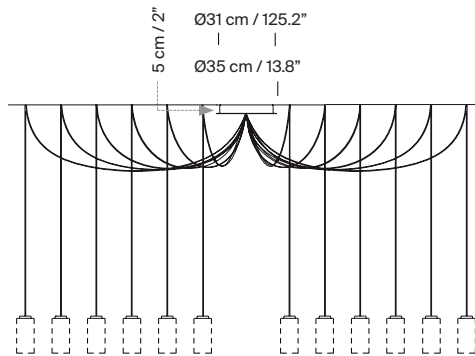

LED capsule with electric black cable	Code
3 m / 118.1"	HEL03UL
8 m / 315"	HEL08UL

Collection: Pendant lamps



Cirio Simple



Cirio Múltiple



Cirio Cascada



Cirio Circular



Cirio Chandelier

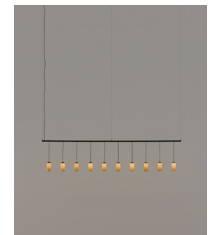

Cirio Lineal

Wall lamps



Cirio Cuadrada



Cirio Pana



Cirio