

Sizes in cm



Materials: Powder-coated finish aluminium injection luminaire. Injected ABS internal reflector. Tempered optical glass seal. The attachment accessory (drawing B) allows a lighting catenary installation with a simple fastening system. Thanks to a 360° rotation on its own axis, facilitates an on-side lighting distribution fully orientable. Metal wire allowed: Ø 6 mm. Stainless steel safety screws.

Colors:



Light grey (RAL 9006)
(other colours available to order)



Dark grey (RAL 7024)

Size (cm): Ø 23 x 22

Weight (kg): 3.7

Surface exposed to wind (m²): 0.028 (lateral)

Installation: Suitable for pole attachment using a fastening accessory not included (see drawing A).

Suitable for catenary attachment using a fastening accessory not included (see drawing B).

(For further information log onto the website www.urbidermis.com)

*Catenary wire not included.

Applicable standards: UNE-EN 60529, UNE-EN 60598, UNE-EN 55015, UNE-EN 61000, UNE-EN 50102, UNE-EN 62031, (tests performed by accredited laboratory ENAC, CE), UL 1598, UL 8750, (file E-505192)

Protections: IP66 (protection from dust ingress and high-pressure water jets), suitable for wet locations, IK08 (protection against external mechanical impacts)

Electrical rating: Class I (CE)

Light source: High-efficiency optical unit with 8 or 12 LEDs or COB

Nominal lamp power (W):

8LEDs: 8, 11

12LEDs: 12, 18

COB: 12, 17

System power (W):

8 LEDs: 11, 15

12 LEDs: 15, 21

COB: 14, 20

Operating current (mA): 350, 500

Color temperature (K°):

3000 CRI min80, 4000 CRI typ70 (COB 4000 CRI min80)

Power supply: constant current driver.

Regulation:

1-10V / Dali / Header flux regulation / Programmable automatic regulation.

The LED luminaire may be regulated using a number of differing interfaces. These controls allow specific, individual control of light, reducing energy consumption in a sustainable manner.

Constant light output (CLO).

Assures a constant lumen output from the luminaire throughout its lifetime.

Power factor (cos φ):

N° LEDs	Current (mA)	P (W) 100% CLO 80%
8	350	0.80
	500	0.87
12	350	0.88
	500	0.92
CoB	350	0.95
	500	0.98

Operating voltage: 220-240V 50Hz (CE) / 120-277V 60Hz (UL)

Wire:

0,6 / 1 kV 3 x 1,5mm²

0,6 / 1 kV 5 x 1,5mm² (prog.)

Temperature operating range Ta (°C): between -25 and 30 (500mA)

Lifetime: TM21 L70 (10k) > 50.000 h

Thanks to an optimised thermal design, the luminous flux is maintained up to 70% after 50.000 h.

Under exceptional cases when the ambient temperature is excessive, the output may be reduced using the (NTC) active control system that ensures the right operating temperature is maintained.

Light distributions:

Symmetrical: Wide Flood (WF 76°), Flood (F 43°), Medium (M 30°), Spot (S 15°), Oval (OV 60°x40°), Lightblade (LB 100°x20°), Type II+II (TII+II).

Asymmetrical: Type II, Type III o Type IV (according to IESNA classification).

Upper Light Output Ratio (ULOR%): 0.60 – 0.88

Configurations

Reference	N°LEDs	T°colour (K)	Lamp power (W)	System power (W)	Current (mA)	IESNA TII		IESNA TIII		IESNA TIV		LightBlade		Oval OV		IESNA TII+II	
						Luminaire luminous flux (lm)	Efficacy (lm/W)	Luminaire luminous flux (lm)	Efficacy (lm/W)	Luminaire luminous flux (lm)	Efficacy (lm/W)	Luminaire luminous flux (lm)	Efficacy (lm/W)	Luminaire luminous flux (lm)	Efficacy (lm/W)	Luminaire luminous flux (lm)	Efficacy (lm/W)
ARPS8A1xx	8	3000 CRI min 80	8	11	350	857	77	806	73	823	74	864	78	945	85	857	77
ARPS8B1xx			11	15	500	1162	77	1092	73	1116	74	1171	78	1281	85	1162	77
ARPS8A2xx		4000 CRI typ 70	8	11	350	1011	91	950	86	971	88	1019	92	1114	100	-	-
ARPS8B2xx			11	15	500	1370	91	1288	86	1316	88	1381	92	1511	100	-	-
ARPS12A1xx	12	3000 CRI min 80	12	15	350	1279	83	1202	78	1228	80	1288	84	1409	92	1279	83
ARPS12B1xx			18	21	500	1748	83	1643	78	1678	80	1761	84	1926	92	1748	83
ARPS12A2xx		4000 CRI typ 70	12	15	350	1508	98	1418	92	1448	94	1519	99	1662	108	-	-
ARPS12B2xx			18	21	500	2061	98	1937	92	1979	94	2077	99	2272	108	-	-
ARPSCOBA1	CoB	3000 CRI min 80	12	14	350	-	-	-	-	-	-	-	-	-	-	-	-
ARPSCOBB1			17	20	500	-	-	-	-	-	-	-	-	-	-	-	-
ARPSCOBA2		4000 CRI typ 80	12	14	350	-	-	-	-	-	-	-	-	-	-	-	-
ARPSCOBB2			17	20	500	-	-	-	-	-	-	-	-	-	-	-	-

*Opal optics: -7.5% luminous flux

Configurations

Reference	N°LEDs	T°colour (K)	Lamp power (W)	System power (W)	Current (mA)	Symmetric WF		Symmetric F		Symmetric M		Symmetric S	
						Luminaire luminous flux (lm)	Efficacy (lm/W)	Luminaire luminous flux (lm)	Efficacy (lm/W)	Luminaire luminous flux (lm)	Efficacy (lm/W)	Luminaire luminous flux (lm)	Efficacy (lm/W)
ARPS8A1xx	8	3000 CRI min 80	8	11	350	896	81	967	87	945	85	927	84
ARPS8B1xx			11	15	500	1215	81	1311	87	1281	85	1257	84
ARPS8A2xx		4000 CRI typ 70	8	11	350	1057	95	1141	103	1114	100	1094	99
ARPS8B2xx			11	15	500	1433	95	1546	103	1510	100	1482	99
ARPS12A1xx	12	3000 CRI min 80	12	15	350	1337	87	1443	94	1409	92	1383	90
ARPS12B1xx			18	21	500	1827	87	1972	94	1926	92	1891	90
ARPS12A2xx		4000 CRI typ 70	12	15	350	1577	103	1701	111	1662	108	1631	106
ARPS12B2xx			18	21	500	2155	102	2325	111	2272	108	2230	106
ARPSCOBA1	CoB	3000 CRI min 80	12	14	350	1634	119	-	-	-	-	-	-
ARPSCOBB1			17	20	500	2234	114	-	-	-	-	-	-
ARPSCOBA2		4000 CRI typ 80	12	14	350	1927	141	-	-	-	-	-	-
ARPSCOBB2			17	20	500	2634	135	-	-	-	-	-	-

*Opal optics: -7.5% luminous flux

Asymmetric
Distribution TII
LOR 100%
ULOR 0%±3%

Max. intensity 573.26 cd/klm

C Halfplanes
0° — 180°
90° - - - 270°
25° ····· 205°

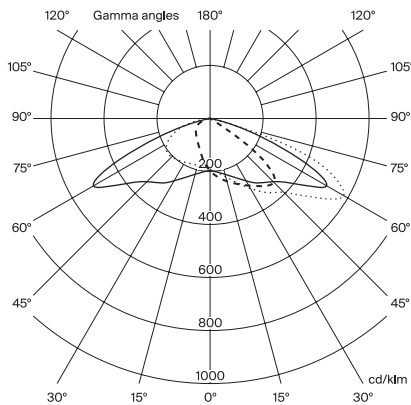

Asymmetric
Distribution TIII
LOR 100%
ULOR 0%±3%

Max. intensity 593.70 cd/klm

C Halfplanes
0° — 180°
90° - - - 270°
40° ····· 220°

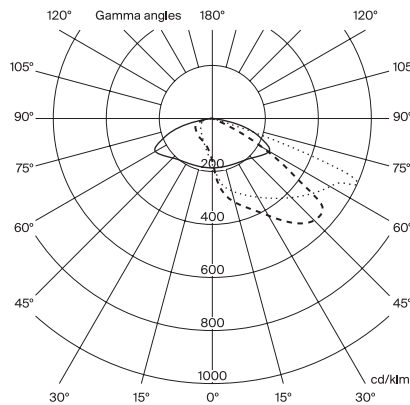

Asymmetric
Distribution TIV
LOR 100%
ULOR 0%±3%

Max. intensity 579.34 cd/klm

C Halfplanes
0° — 180°
90° - - - 270°
65° ····· 245°

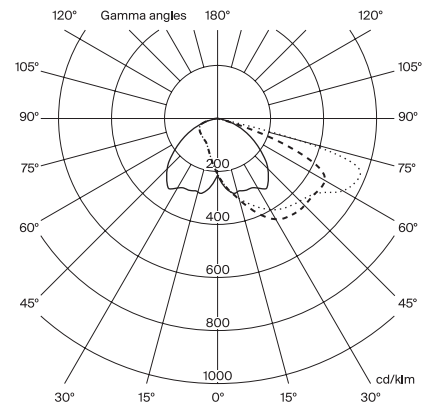

Symmetric
Distribution Wide Flood
LOR 100%
ULOR 0%±3%

Máx. intensity 671.25 cd/klm

C Halfplanes
0° — 180°
90° - - - 270°

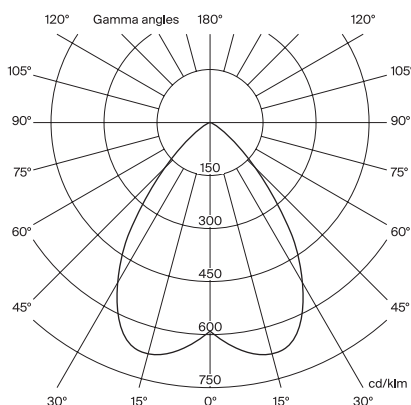

Symmetric
Distribution Flood
LOR 100%
ULOR 0%±3%

Máx. intensity 1466.62 cd/klm

C Halfplanes
0° — 180°
90° - - - 270°

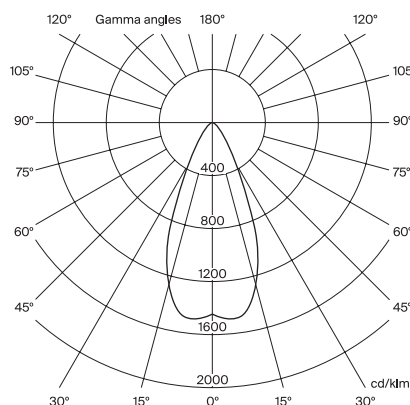

Symmetric
Distribution Medium
LOR 100%
ULOR 0%±3%

Máx. intensity 1951.75 cd/klm

C Halfplanes
0° — 180°
90° - - - 270°

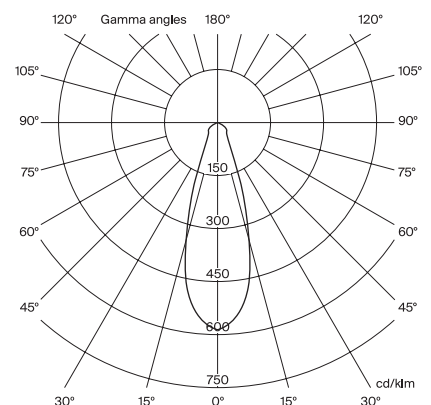

Symmetric
Distribution Spot
LOR 100%
ULOR 0%±3%
Max. intensity 7697.66 cd/klm

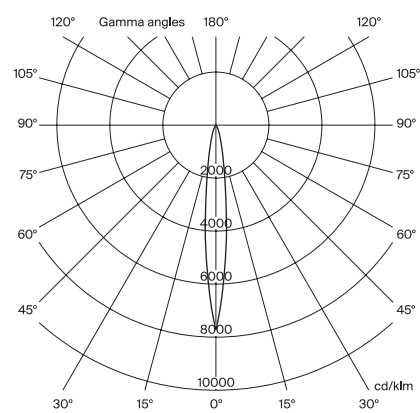

Symmetric
Distribution LightBlade
LOR 100%
ULOR 0%±3%
Max. intensity 1128.56 cd/klm

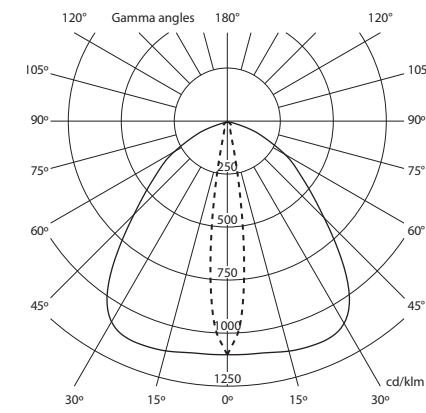

Symmetric
Distribution Oval
LOR 100%
ULOR 0%±3%
Max. intensity 1415.29 cd/klm

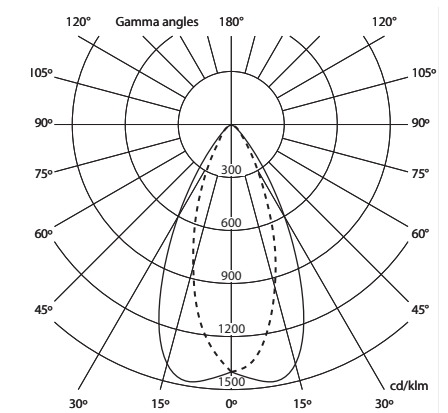

Symmetric
Distribution TII+II
LOR 100%
ULOR 0%±3%
Max. intensity 509.57 cd/klm

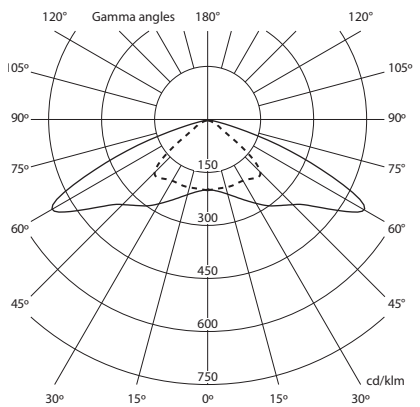

Symmetric
Distribution Wide Flood COB
LOR 100%
ULOR 0%±3%
Max. intensity 514.90 cd/klm

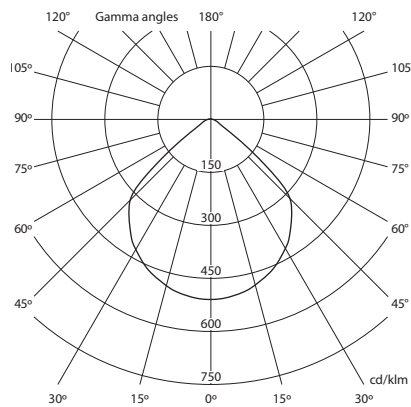

For calculation in ground type II (according to UNE-40) and wind speed of 29 m/s, with soil formed by loose or wet dirt or sand of medium compactness ($E_0 = 4800 \text{ KN/m}^2$), with HM-20 concrete. Non-binding information. We advise to carry out checks for each situation.