

SISTEMA FONDA - P1

1990
GABRIEL ORDEIG COLE



SANTA & COLE

Sistema de suspensión

Pendant system

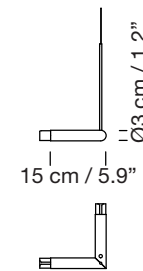
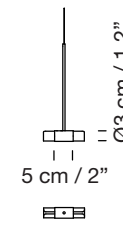
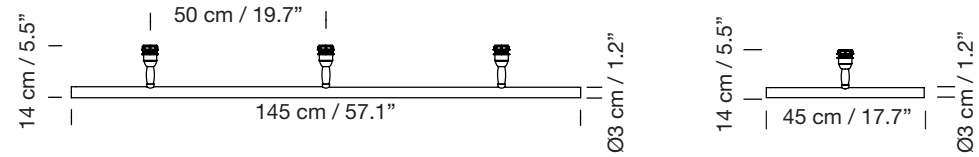
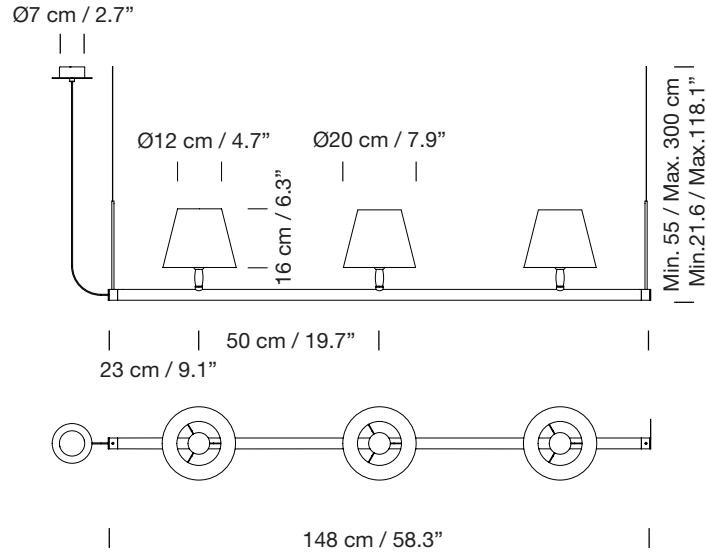

Ejemplos de composición

Composition examples

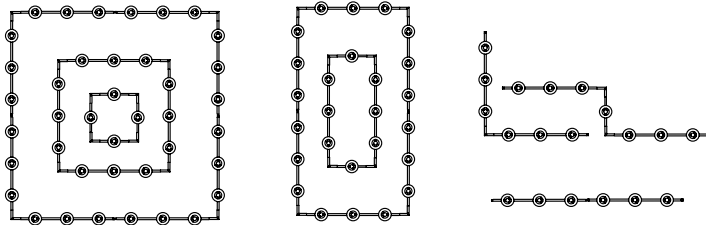

Parc de Belloch. Ctra. C-251 Km 5,6 E-08430 La Roca (Barcelona). España / Spain T. +34 938 679 100 / F. +34 938 711 767

AVISO LEGAL: Reservados todos los derechos. Quedan rigurosamente prohibidas, sin la autorización previa, expresa y por escrito de los titulares de derechos, la reproducción total o parcial de la presente obra/s en cualquier medio o soporte, su distribución, comunicación pública, transformación, así como su fabricación, oferta, comercialización, importación, exportación o uso y almacenamiento de un producto que incorpore el diseño protegido, bajo las sanciones civiles y/o penales establecidas en las leyes y las indemnizaciones por daños y perjuicios que corresponda. LEGAL NOTICE: All rights reserved. Except as specifically agreed in writing, and subject to the civil or criminal actions and the corresponding compensation for damages, the following acts are prohibited: (1) the copyright work may not be reproduced, distributed, communicated to the public, or transformed, in relation to the work as a whole or any part of it, either directly or indirectly; (2) the protected design may not be used by any third party; such use shall cover, in particular, the making, offering, putting on the market, importing, exporting, or using of a product in which the design is incorporated or to which it is applied, or stocking such a product for those purposes.